

DENERIS PLUS

SCHEDA TECNICA - FICHE TECHNIQUE - TECHNICAL DETAILS

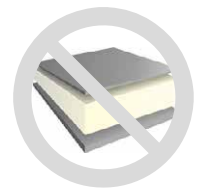

- BIANCO 306
- ANTRACITE 310
- SABBIA 312

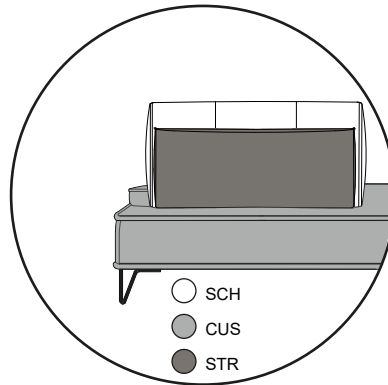
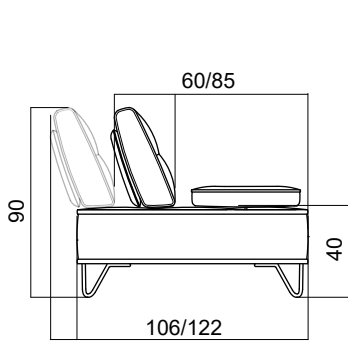

C10F0

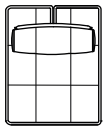

86

C15F0

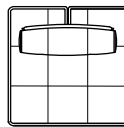

106

M01FS

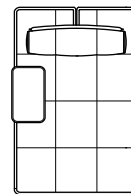

106/123

160/175

M01FD

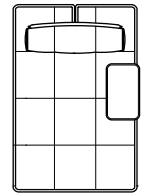

106/123

160/175

D20F0

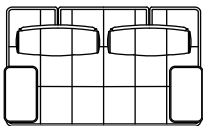

166/200

B20FD

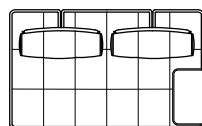

166/183

B20FS

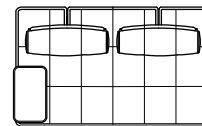

166/183

C20F0

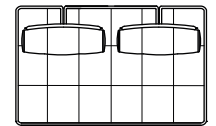

166

D30F0

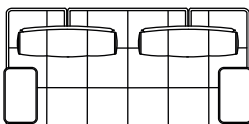

206/240

B30FD

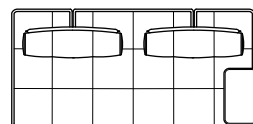

206/223

B30FS

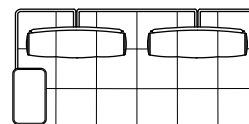

206/223

C30F0

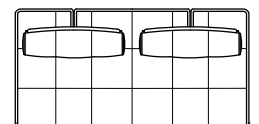

206

P01F0

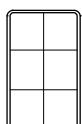

55

106

P02F0

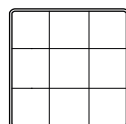

106

106

TES01

58

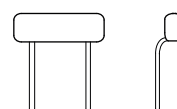

- Poggiatesta volante
- Repose-tete amovible
- Freestanding back cushions

DENERIS PLUS

SCHEDA TECNICA - FICHE TECHNIQUE - TECHNICAL DETAILS

Scheda Tecnica

STRUTTURA - Struttura portante in legno massello e pannelli in agglomerato o multistrato.

IMBOTTITURA SEDUTE - Poliuretano HT 35 kg/m³.

IMBOTTITURA SCHIENALI - Poliuretano 21 kg/m³ + poliuretano 25kg/m³.

PIEDI - Piede metallico disponibile nei colori: Antracite 310, Sabbia 312, Bianco 306.

SOSPENSIONI - cinghie elastiche incrociate.

MECCANICA SCHIENALI - Meccanica schienali Avanti/Indietro manuale (versione elettrica non disponibile).

MECCANICA BRACCIOLO - Meccanica braccioli Avanti/Indietro manuale (versione elettrica non disponibile).

*Le dimensioni di tutti i divani non possono essere precise in ragione della natura stessa dei mobili imbottiti.

Una tolleranza del 3% in più o in meno sulle misure indicate nelle vostre schede tecniche o listini è da considerarsi di rigore.

*La ripartizione dei colori non è modificabile.

*Per le combinazioni di rivestimenti in categorie diverse il prezzo è determinato dal rivestimento della categoria superiore.

Fiche Technique

STRUCTURE - Structure portante en bois massif et panneaux agglomérés ou multicouches.

GARNISSAGE ASSISES - Mousse polyuréthane HT 35 kg/m³.

GARNISSAGE DOSSIERS - Mousse polyuréthane 21 kg/m³ + mousse polyuréthane 25 kg/m³.

PIEDS - Pieds métalliques disponibles dans les couleurs: Anthracite 310, Sable 312, Blanc 306.

SUSPENSIONS - Sangles élastiques entrecroisées.

MECANIQUE DOSSIERS - Mécanique Avance/Reculé manuelle (version électrique pas disponible).

MECANIQUE ACCOUDOIRS - Mécanique Avance/Reculé manuelle (version électrique pas disponible).

*Les dimensions hors tout des canapés ne peuvent pas être précises en raison de la nature même des meubles rembourrés ou matelassés.

Une tolérance de 3% en plus ou en moins sur les mesures indiquées sur vos fiches techniques ou tarifs est de rigueur.

*La répartition des couleurs n'est pas modifiable.

*Pour les mélanges de revêtements en catégories différentes, le prix est déterminé par le revêtement de la catégorie supérieure.

Technical Details

STRUCTURE - Frame in solid wood with plywood or multilayer.

PADDING FOR SEAT - Polyurethane foam HT 35 kg/m³.

PADDING FOR BACK - Polyurethane foam 21 kg/m³ + polyurethane foam 25 kg/m³.

FEET - Section metal feet availables in the colors: Anthracite 310, Sand 312, White 306.

SUSPENSIONS - Elastic crossing belts.

BACK MECHANISM - Manual mechanism forward / backward (electric version not available).

ARMS MECHANISM - Manual mechanism forward / backward (electric version not available).

*The sofas dimensions may have a little tolerance of +/- 3 %, cause of the their nature made with soft material like foam.

*The distribution of colors can not be changed.

*When coverings of different categories are combined, the price is calculated on the basis of the higher one.



SU MISURA NON DISPONIBILE
SUR MESURE PAS DISPONIBLE
CUSTOMIZED NOT AVAILABLE



DENSITÀ DIFFERENTI DI GOMMA NON DISPONIBILI
DENSITÉS DIFFÉRENTES PAS DISPONIBLES
FOAM IN DIFFERENT DENSITIES NOT AVAILABLE